

This drawing includes confidential information which is the property of ASHCROFT INC. This copy is loaned for a specific purpose, with the understanding that it will not be reproduced or used for any other purpose or disclosed to others, and it will be returned on demand.

**ASHCROFT**® INC.

250 EAST MAIN STREET  
STRATFORD, CT 06614

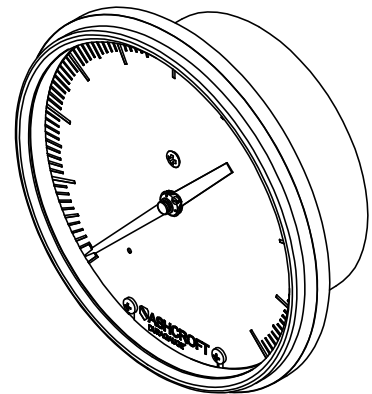
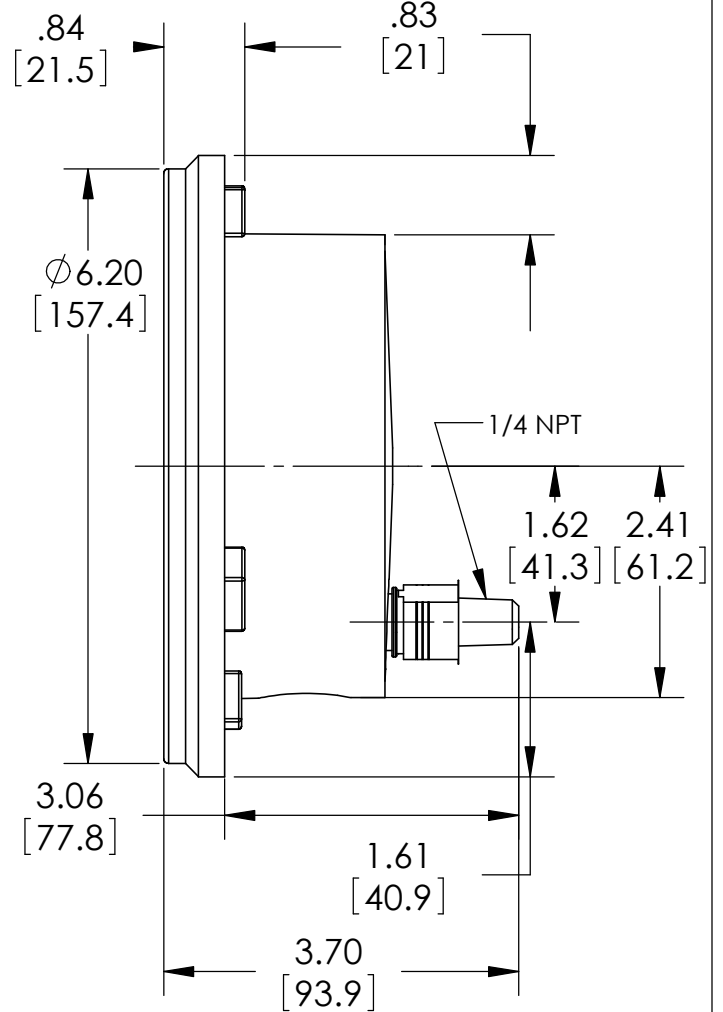
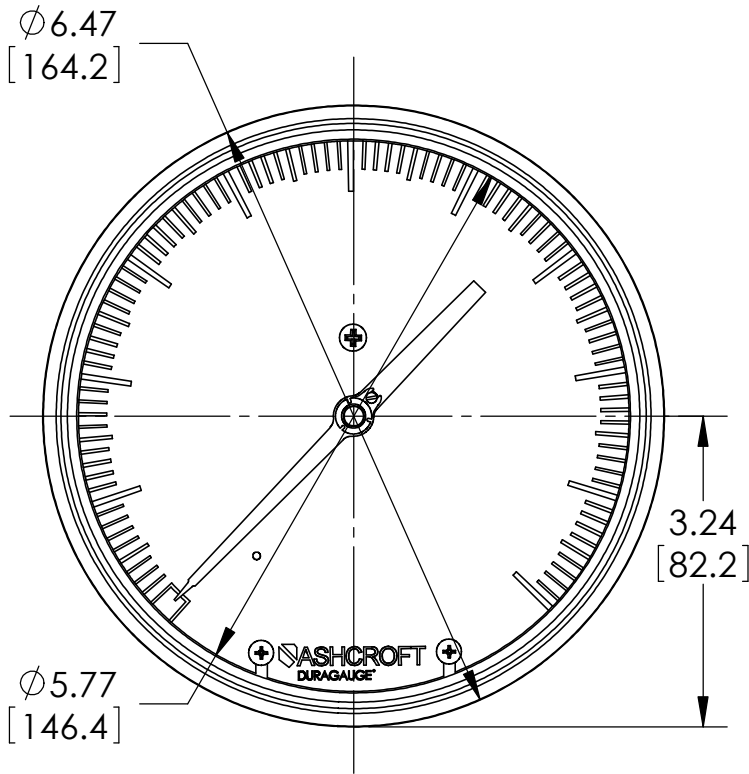

DIMENSIONS IN [ ] ARE MILLIMETERS

REV.	ECO	DESCRIPTION	BY	DATE
B	0007035	REDEFINED AS 60 2462 02B	ALH	2/27/2014

This print certified correct for		<b>General Dimensions</b>			
Customer's Name		60 2462 02B SERIES			
		POLYPROPYLENE CASE DURAGAUGE			
Customer's Order No.		Drawn MJS	Date 6/1/10	Date of Issue	
Ashcroft Order No.		Checked	Date	SHEET-1	
Certified by	Date	Approved	Date	<b>70A3040</b>	<b>B</b>