

ASHCROFT®

Digital Industrial Gauge

Operating Instructions



Congratulations on your purchase of the Ashcroft® digital industrial gauge. This feature-packed gauge offers a menu-driven display for easy customization. User selectable features include 12 units of measurement, password protected calibration and disable functions, adjustable bar graph and update rate. A five digit display for maximum resolution is standard. Optional 4-20mA output, switching and line- power add to the versatility of the gauge. With the range printed on the keypad, Ashcroft digital gauges meet ASME B40.7 specification. See a complete listing of product features and specifications on pages 16.

Ashcroft Inc.
250 East Main Street | Stratford, CT 06614-5145
Tel: 203-378-8281 | Fax: 203-385-0602
e-mail: info@ashcroft.com | www.ashcroft.com

TABLE OF CONTENTS

Quick Reference	4-5
Keypad Functions	6-8
<ul style="list-style-type: none">• ON/OFF KEY• ZERO/CLEAR KEY• MIN/MAX KEY ▼ (down arrow key)• MENU KEY• BACKLITE KEY ▲ (up arrow key)• ENTER KEY	
MENU Functions (MENU Mode)	8-15
<ul style="list-style-type: none">• Engineering Units• CONFIG Mode<ul style="list-style-type: none">• Set Password• Recalibration of Gauge• Zero Key Adjustment• Disabling Menu Options• Bar Graph Options• Auto Off Options• Update Options for Displayed Pressure• Dampening Options• Backlite Options (Backlite Optional)• Set Switch(es) Option(s) (Switches Optional)	
Specifications	16
Ranges	17
Display Messages	17
Wiring Diagrams	18-29
Gauge Installation & Maintenance	30-32
<ul style="list-style-type: none">• Mounting• Battery Replacement & Installation	

*.88" high digital display (4½" case)
.60 high digital display (3" case)*

*Bar graph
% of full scale*

*Flashing display when unit
pressured below zero*

*Press to indicate minimum
or maximum pressure
gauge has measured
Press again to return to
pressure units*

Press to read menu

UNITS (Pressure)

ENGLISH

INHG

PSI*

INH2O

@ 4°C, 20°C, 60°F

FTW

FTSW

METRIC

BAR

MBAR

KPA

CMH2O

KG/CM2

*UPDATE RATE
(Pressure measurement
per second)*

10x (100 MS)*

5x (200 MS)

2x (500 MS)

1x (1 Sec)

*BACKLITE
(Off options)*

Never

2 SEC

5 SEC*

15 MIN

30 MIN

REFERENCE



Press to turn unit on or off

While in unit of measurement mode (eg: psi), press the ZERO CLEAR button to rezero the gauge. This feature functions when displayed pressure is within $\pm 5\%$ or 10% of zero value

Flashing display when unit pressurized beyond full-scale

This bar graph indicates battery level; the more segments, the closer the battery is to full charge (only displayed on units with battery)

Press to turn backlight on or off (backlite optional)

Range on keypad; complies with ASME B40.7

AUTO OFF
(Turns unit off after option selected)

Never*
2 minutes
5 minutes
15 minutes
30 minutes

CALIBRATE
Zero and span adjustments, password protected

DAMPENING
(Takes pressure reading and averages process pressure)

None*
Avg 2
Avg 4
Avg 6
Avg 8

DISABLE
Allows for "lockout" of MENU options

***Indicates Default**

KEYPAD FUNCTIONS



Turns the gauge on and off. When pressing the ON/OFF key while in the off position, gauge start-up display first indicates the software version followed by the model number and gauge pressure range. The gauge will then display indicated pressure and be ready for use.



Press this key for one second prior to gauge usage to rezero any initial zero shift. If zero shift is greater than programmed zero allowance, the gauge will display OFSET (blinking) for 1 second, then return to the measure mode. To clear minimum and maximum values, press ZERO/CLR button (when min/max values are indicated). Gauge will auto advance once zeroed.



The Max/Min key allows review of minimum and maximum pressure values since unit start-up or last push of the clear key. Press key to:

- 1) Indicate maximum pressure.
- 2) Indicate minimum pressure.
- 3) Exit MAX/MIN mode and return the unit to pressure measurement mode. To clear minimum and maximum values press ZERO/CLR key (must be in MAX/MIN mode).

The ▼ (down arrow key) is used in the MENU mode, see following MENU key section.

KEYPAD FUNCTIONS



This key allows for customization of the gauge. Pressing the MENU key allows cycling through the main MENU items; UNITS, CONFIG, GRAPH, OFF, UPDAT & DAMP. Any item changed in the Menu become the new default setting(s). Revised settings are saved in the event of power loss.

The ▲ (up arrow key) or ▼ (down arrow key) on the keypad allows for scrolling through the MENU options to increase or decrease numeric values as required. If in the menu mode, gauge will automatically advance to measure mode once selected MENU item has been set.



Key for gauge
with Backlite

Key for gauge
without Backlite
displayed with
▲ (up arrow
icon only)

This key manually turns the backlight on or off. Five options are available. They include NEVER, 10 sec, 30, sec, 1 min, 5 min*. With the NEVER option, the gauge BACKLITE will remain lit whenever the gauge is in the ON mode or until the BACKLITE button is pushed again. Options, 10 sec, 30 sec, 1 min, 5 min*. allow the BACKLITE to automatically turn-off after a selected period of time.

To use the BACKLITE option:

Step 1: Press the MENU key.

Step 2: Press the ▲ (up arrow key) or ▼ (down arrow key) until the word LITE appears.

Step 3: Press ENTER.

Step 4: Press the ▲ (up arrow key) or ▼ (down arrow key) to select the BACKLITE option.

Step 5: Press the ENTER key to finalize your choice of LITE options.

KEYPAD FUNCTIONS



This key allows for selecting gauge features in the menu finalizing selection. Use of the enter key is described throughout operating instructions.

MENU OPTIONS

UNITS: 12 units of measurement are available: psi, mmHG, inH₂O with three temperature options: 20°C, 60°F, 4°C*, mBar, inHg, ftH₂O, mPa, kPa, kg/cm² and bar.

Step 1: Press the MENU key until the word UNITS appears.

Step 2: Press ENTER.

Step 3: Press the ▲ (up arrow key) or ▼ (down arrow key) to select the required unit of measure.

Step 4: Press ENTER to finalize the UNIT selection.

Note: For inH₂O range with three temperature options, press the ▲ (up arrow key) and ▼ (down arrow key) to select the desired temperature, then press ENTER to finalize the UNIT selection.

CONFIG: This option allows access to additional Menu options. Options include:

- **ENTPW** or enter password (*this appears as a sub-menu in the CONFIG mode if a user password has been set*).
- **RECAL** (allows for zero, span and mid-scale calibration of the gauge).
- **ObUTN** or zero key (allows for adjustment of % of range that can be zeroed),
- **dISAb**, allows for disabling MENU options.
- **SETPW:** This feature allows for a user defined numeric password. If a user password is not set, all features in the CONFIG mode will be accessible without a password. If a user password is set, all items in the CONFIG menu options are accessible with or without a user password. If a user password is programmed, it will be required to access the CONFIG menu options. Default user password is 12045 or 12*45.

* Indicates default.

MENU FUNCTIONS

How to Use Your Menu Functions

To set a user password (SETPW):

Step 1: Press the MENU key on the keypad

Step 2: Press the ▲ (up arrow key) or ▼ (down arrow key) until the word CONFIG appears.

Step 3: Press ENTER. The word SETPW appears on the gauge display

Step 4: Press ENTER. A five digit numeric password is now required.

Step 5: Press the ▲ (up arrow key) or ▼ (down arrow key) on the keypad to select the first digit of the password.

Step 6: Press ENTER.

Step 7: Repeat until the five-digit password is shown on the gauge display.

Step 8: Press ENTER.

Note: to erase password at any time while in the SETPW (set password) mode, press the ZERO/CLEAR key. The user will be prompted to reprogram the password once the five-digit password is entered. The gauge will display SAVE.

Step 9: Press ENTER to save the password setting.

ENTPW: Once a user password has been established and entry into the CONFIG mode is required, the user will be prompted to ENTPW or enter password.

Follow setup steps 4-8 above.

RECAL: or recalibrate allows for zero, mid-scale, full-scale and factory default calibration of the gauge. The RECAL feature also allows for recalibration of gauges with 4-20mA output.

*Indicates default.

MENU FUNCTIONS

To use RECAL option:

Step 1: Press the MENU key on the keypad

Step 2: Press the ▲ (up arrow key) or ▼ (down arrow key) on the keypad until the word CONFIG appears.

Step 3: Press ENTER.

Step 4: Enter user password if it has been programmed.

Step 5: Press ▲ (up arrow key) or ▼ (down arrow key) until the word RECAL appears.

Step 6: Press ENTER.

Step 7: The gauge will now flash between INPUT and unit of measure on the lower line and .00 on the top line. Apply zero pressure to the gauge.

Step 8: Press ENTER. Zero pressure is now set.

Step 9: The gauge will display full-scale pressure. Apply full-scale pressure to the gauge.

Step 10: Press ENTER. Full-scale pressure is now set.

Step 11: The gauge will now display mid-scale pressure. Apply mid-scale pressure to the gauge.

Step 12: Press ENTER. Mid-scale pressure is now set.

Step 13: After zero, full-scale and/or mid-scale or factory default calibration have been set, the word SAVE appears on the gauge display.

Step 14: Press ENTER to finalize calibration.

(Note: For compound ranges this recalibration is zero, full-scale, mid-scale and full-vac.)

FOR FACTORY CALIBRATED SETTINGS:

To reinstate factory settings for zero, full-scale and mid-scale follow RECAL steps 1-6

Step 7: When the word INPUT appears press ▲ (up arrow key) until the word FACT appears.

Step 8: Press ENTER to finalize calibration.

* Indicates default.

MENU FUNCTIONS

Note: Calibration of Zero, mid-scale or span can be set independently of each other. For instance, if only full-scale calibration is required, press the ▼ (down arrow key) until the gauge display indicates full-scale pressure. Press Enter and proceed as indicated above. Calibration of zero, midscale and full-scale is recommended when recalibrating the gauge.

ZERO KEY (0bUTN): This feature allows the user to select percent of full-scale at which the gauge can be rezeroed using the Zero/Clear key on the keypad. Options include 5% full-scale*, 10% full-scale or DISAB (disable of the zero key).

To use ZERO option:

Step 1: Press the MENU key on the keypad.

Step 2: Press the ▲ (up arrow key) or ▼ (down arrow key) until the word CONFIG appears.

Step 3: Press ENTER.

Step 4: Enter user password, if it has been programmed.

Step 5: Press the ▲ (up arrow key) or ▼ (down arrow key) until the word 0bUTN (zero key) appears.

Step 6: Press ENTER.

Step 7: Press the ▲ (up arrow key) or ▼ (down arrow key) to select 5PCT (5% full-scale), dISAb (disable zero key) or 10PCT (10% full-scale).

Step 8: Press ENTER to finalize the selection.

DISAB: or disable: This feature allows the user to dISAb (or disable) or ENAb (enable) items in the MENU. Some keypad keys can also be enabled or disabled. Any or all MENU items can be enabled or disabled.

To use DISAB option:

Step 1: Press the MENU key on the keypad.

Step 2: Press the ▲ (up arrow key) or ▼ (down arrow key) until the word dISAb appears.

* Indicates default.

MENU FUNCTIONS

Step 3: press ENTER. The current setting (ENAB or DISAB) will be displayed.

Step 4: Press the ▲ (up arrow key) or ▼ (down arrow key) on the keypad to select a setting.

Step 5: Press ENTER To finalize the setting.

GRAPH: This option allows the user to change the BAR graph on the gauge display to correspond to any desired pressure within the pressure limits of the gauge. This option is useful when identifying a select portion of the full-scale range of the gauge. The default setting for the GRAPH is zero and full-scale pressure. For compound gauges, the default setting for zero is set at full-scale vacuum. Full-scale pressure is set at the positive pressure as displayed on the gauge keypad.

For gauges supplied with the 4-20mA output option, the default is 4mA equals 0% of the bar graph and 20 mA equals 100% of the bar graph.

Changing the bar graph to a pressure other than 0 and 100% of range will also change the 4-20mA output to correspond with the new bar graph pressures for 0 and 100%.

To use GRAPH option:

Step 1: Press the MENU key.

Step 2: Press the ▲ (up arrow key) or ▼ (down arrow key) on the keypad until the word until the word GRAPH appears.

Step 3: Press ENTER . The gauge display will indicate the set full scale pressure range setting on the top line. The middle line indicates the bar graph at 100% of full-scale. The bottom line of the display will indicate SETFS to set the full-scale range as displayed by the bar graph and 4-20mA.

Step 4: Press the ▲ (up arrow key) or ▼ (down arrow key) on the keypad to increase or decrease gauge value at 100% of range.

* Indicates default.

MENU FUNCTIONS

Step 5: Press the ENTER key to finalize your choice. The gauge display will now display SET. After two seconds the screen will display the pressure value for 0% on the top line. The middle line indicates the bar graph at 100% of fullscale. The bottom line will display SET 0.

Step 6: Press the ▲ (up arrow key) or ▼ (down arrow key) on the keypad to increase or decrease gauge value at 0% of range.

Step 7: Press the ENTER key to finalize your choice. The new values for the bar graph and 4/20mA settings have now been saved.

OFF: This option sets the amount of time before the gauge will turn itself off. Offerings are Never*, 30MIN, 10MIN, 5MIN, 2 MIN.

To use the OFF option:

Step 1: Press the MENU key.

Step 2: Press the ▲ (up arrow key) or ▼ (down arrow key) until the word OFF appears.

Step 3: Press ENTER.

Step 4: Press the ▲ (up arrow key) or ▼ (down arrow key) to select the desired OFF time.

Step 5: Press the ENTER key to finalize the OFF setting.

UPDATE: This option allows for changing the rate at which pressure is updated on the display screen. This feature is useful with rapid changes in process pressure that may cause flutter of the display. Options are 100ms*, 1 sec, 500ms and 200ms, updates per second or 100ms*.

Since customer processes vary, update rates should be selected based on the application.

To use the UPDATE option:

Step 1: Press the MENU key.

* Indicates default.

MENU FUNCTIONS

Step 2: Press the ▲ (up arrow key) or ▼ (down arrow key) until the word UPDATE appears.

Step 3: Press ENTER.

Step 4: Press the ▲ (up arrow key) or ▼ (down arrow key) to select an update rate.

Step 5: Press ENTER to finalize the selection.

DAMP or dampening: with five different options, this mode allows for taking process pressure readings and averaging them. This option is particularly useful to stabilize minor process fluctuations. The options are NONE*, AVG 8, AVG 6, AVG 4, AVG 2.

Step 1: Press the MENU key until the word dAMP appears.

Step 2: Press ENTER.

Step 3: Press the ▲ (up arrow key) or ▼ (down arrow key) to select a dampening option.

Step 4: Press the ENTER key to finalize your Damp option.

(This Menu item is only seen on units with the switch option)

SWSET: Allows for setting switch setpoints. The gauge is offered with (1) or (2) SPDT switches. If (1) SPDT switch is ordered the menu option is SW1. If (2) SPDT switches are ordered, the MENU options are SW1 and SW2.

Step 1: Press the MENU key.

Step 2: Press the ▲ (up arrow key) or ▼ (down arrow key) on the keypad to select the switch to be set. (If two switches are present.)

Step 3: Press ENTER. The top line of the gauge display will indicate pressure at 60% of the full-scale gauge range* or the most recent switch setpoint. The middle line of the display will indicate a bar graph that displays the pressure

* Indicates default.

MENU FUNCTIONS

position within the pressure range. The bottom line will display SETPT (blinking). SETPT is switch setpoint on rising pressure.

Note: Setpoints are limited to the full-scale pressure range of the gauge.

Step 4: Press the ▲ (up arrow key) or ▼ (down arrow key) on the keypad to increase or decrease switch set-point

Step 5: Press the ENTER key to finalize switch setpoint. The gauge will display SET. After two seconds, the top line will indicate RETRP pressure. The bottom line will read SET. RETRP is switch setpoint on falling pressure.

Step 6: Repeat above to set RETRP (retrip value) If the gauge is supplied with (1) setpoint, the screen will advance to the measurement mode. If (2) switches are supplied the display will advance to SW2.

Repeat the aforementioned if the gauge is supplied with (2) switches.

Notes: The bar graph will increase or decrease as any setpoint pressure is adjusted. The bar graph indicates switch setpoint position within the full-scale pressure range of the gauge.

The switch setpoint unit of pressure measurement corresponds with the current set unit of measure of the gauge. If gauge unit of measurement is changed after switch(es) is set, switch setpoint(s) will automatically be updated to correspond with revised unit of measurement. Switch deadband is the difference between the SETPT (setpoint) and the RETRP (retrip) pressure.

DIGITAL INDUSTRIAL GAUGE SPECIFICATIONS

Type:	2074 (battery), 2174 (loop), 2274 (line)
Accuracy:	.25% Full Scale, terminal point
Case Size:	3", 4 1/2"
Case Material:	3" SS, 4 1/2" fiberglass reinforced thermoplastic or black epoxy coated aluminum
Case Encl. Rating:	Weatherproof, IP65
Wetted Materials:	17-4 SS (sensor), 316SS (socket)
Socket Size:	1/4 or 1/2 NPT, JIS, DIN, SAE, (1/2 NPT only with 4 1/2" case, others on application)
Socket Location:	Lower, 3, 9 and 12 o'clock
Ranges:	Vac. thru 20,000 psi (see engineering units below for other units)
Operating Temp.:	14/140°F (10/60°C)
Storage Temp.:	-4/158°F (-20/70°C)
DISPLAY	
Type:	LCD
Display Digits:	Five (5)
Character Height:	3" .60", 4 1/2" .88"
Backlite:	Optional
Bar Graph:	Yes
Battery Life:	3" >1000 hrs., 4 1/2" >3600 hrs.
Agency Approvals:	CE, FM* (Intrinsically Safe Class1, Div 1), CSA *FM is not available with the following: 4 1/2" polypropylene case, SPDT switch option(s) (XU1, U2) or Backlite (XBL) option)
KEYPAD FUNCTIONS	
On/Off:	Manually turns unit on and off (auto off options in menu)
Zero/Clear:	Zeros display or clears min. and max. values when displayed
Min/Max ▼ (down) Arrow Key:	Stores min and max values, arrow key allows for scrolling thru menu items
Menu Key:	Provides access to menu options
Backlite ▲ (up) Arrow Key: (Backlite optional)	Manually turns backlite on and off (auto off options in menu), arrow key allows for five menu options. ▲ (up) arrow key allows for scrolling thru menu options
Enter:	Selects items in the menu
MENU MODE	
Engineering Units:	10 units of measurement are available; psi, In. H ₂ O (with three temp. options: 20°C, 60°F, 4°C*), Ft. H ₂ O, mPa, mBar, kPa, kg/cm ² , Bar, inHg and mmHg
Configuration Mode (Config):	Allows for changes to default settings of gauge including zero disable feature
Bar Graph (Graph):	Allows for adjustment of bargraph and 4-20 (optional feature)
Auto Off (Off):	Allows for changes to auto off of gauge, five options: Never, 2 min., 5 min., 15 min., 30 min.
Update Rate (Update):	Four options: 100 ms, 200 ms, 500 ms, 1 sec
Dampening (Damp):	Six options: None, average, 2, 4, 6, 8 times per 100ms
Backlite:	Five options: Never, 10 sec., 30 sec., 1 min., 5 min.
Field Recalibration:	Allows for recalibration of zero, midscale and span (password protected)
OPTIONS	
4-20mA Display:	12-36 Vdc, mA with unlimited turndown (within gauge range)
Line Powered:	12-36 Vdc, 2VA max.
Switching*:	(1) or (2) SPDT switches, (max. contact 30Vdc, 1 amp, 125Vac .5 Amp, Switches adjustable to 100% of range

DIGITAL INDUSTRIAL GAUGE RANGES

Note: Rows listed are not the equivalent of each other.

psi	in.Hg (vacuum)	Comp. (psi)	mmHg (pressure)	in.Hg (pressure)	in. H ₂ O	mBar	ft. H ₂ O	mPa	kPa	Bar/ KSC
15	30	-15/0/15	800	30	400	1000	60	1	100	1
30		-15/0/30	1000	60	800	1500	160	1.6	160	1.6
60		-15/0/60	2000	100	1000	2000	200	2.5	250	2.5
100		-15/0/100	3000	160		2500	300	4	400	4
160			5000	200		4000	400	6	600	6
200			10,000	300		5000	600	10	1000	10
300				400		6000	1000	16	1600	16
600				600		10,000		25	2500	25
800				800		15,000		40	4000	40
1000						20,000		60	6000	60
1500								100	10,000	100
2000								140	16,000	160
3000									25,000	250
5000									40,000	400
8000									60,000	600
10,000									100,000	1000
15,000									140,000	1400
20,000										

DISPLAY MESSAGES:

Display/Problem	Description	Action
No Battery Icon Display (applicable to gauges with batteries)	Gauge has <10% battery life left	Replace batteries
OFFSET (blinking)	Zero/Clear button pushed when pressure displayed is beyond set rezero pressure limit	Only rezero the gauge within limits of setting in Menu
Menu button disabled	Gauge is in Max/Min mode	Push Max/Min button until unit of measure is displayed on keypad
Unit of measure selected in Menu displays N/A	Resolution at full scale pressure range exceeds 50,000 counts	Choose another unit of measure
I can't set the password I want	00000 is not a valid password	Select a different password
I can't access items in the main Menu	Items that cannot be accessed have been disabled	Enable item(s) in the Menu. See Menu/CONFIG and diSAb or DISABLE

WIRING DIAGRAM

Loop Powered 4-20mA (Type 2174)

2 conductor, 20 AWG shielded

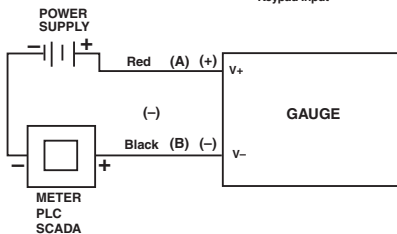
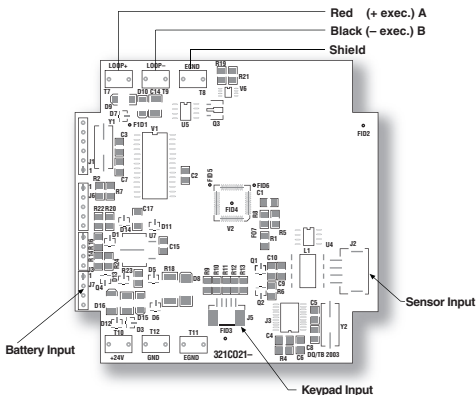

Installation Procedure for 2174:

- ⚠ ESD precautions should be taken. See page 31 for details.
1. Ensure all power is off/disconnected from the circuit.
 2. Connect the red wire (A) to the positive power terminal.
 3. Connect the black wire (B) to the positive terminal on the meter.
 4. Connect the negative side of the meter to the negative power terminal.

Note: Meter should be installed on the black wire only.

Load Limitations 4-20mA Output Only

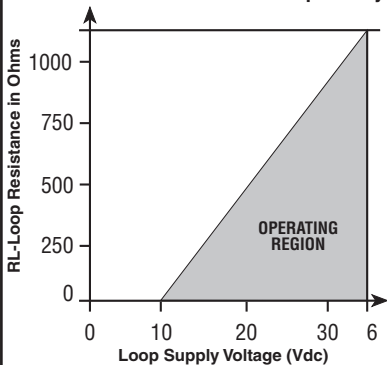

$$\mathbf{Vdc\ MIN = 12V + [0.022A \times (RL)]}$$

$$R_L = R_S + R_W$$

R_L = Loop Resistance (ohms)

R_S = Sense Resistance (ohms)

R_W = Wiring Resistance (ohms)

WIRING DIAGRAM

Line Powered (Type 2274)

2 conductor, 20 AWG shielded

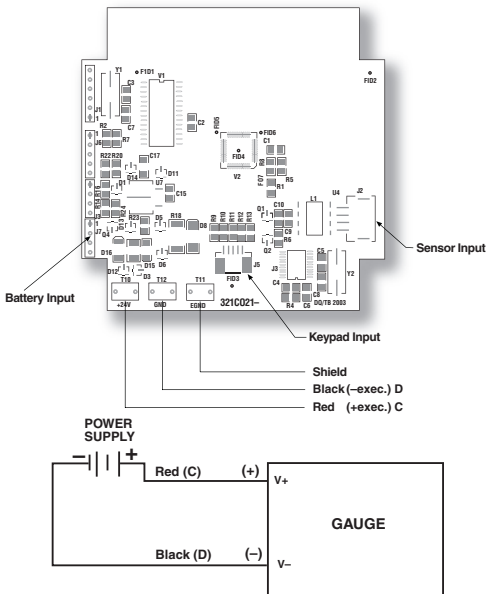

Installation Procedure for 2274:

- ⚠ ESD precautions should be taken. See page 31 for details.
- 1. Ensure all power is off/disconnected from the circuit.
- 2. Connect the red wire (C) to the positive power terminal.
- 3. Connect the black wire (D) to the negative power terminal.

WIRING DIAGRAM

Line Powered with (1) SPDT switch (Type 2274 XU1)
 5 conductor, 22 AWG shielded

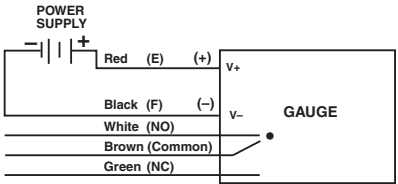
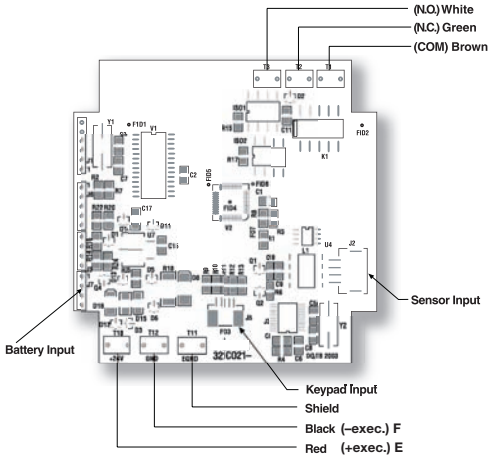

Installation Procedure for 2274 XU1:

- ⚠ ESD precautions should be taken. See page 31 for details.
- 1. Ensure all power is off/disconnected from the circuit.
- 2. Connect the red wire (E) to the positive power terminal.
- 3. Connect the black wire (F) to the negative power terminal.

Wiring the Switch:

Normally Open: Use the white and brown wires.
 Normally Closed: Use the green and brown wires.

WIRING DIAGRAM

Line Powered with (2) SPDT switches (Type 2274 XU2)
8 conductor, 22 AWG shielded

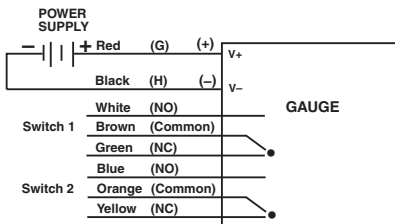
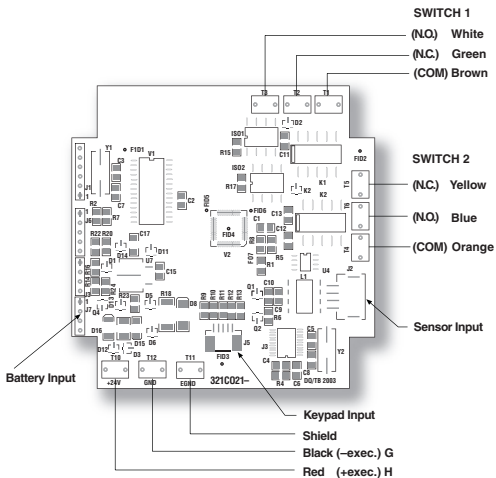

Installation Procedure for 2274 XU2:

 ESD precautions should be taken. See page 31 for details.

1. Ensure all power is off/disconnected from the circuit.
2. Connect the red wire (G) to the positive power terminal.
3. Connect the black wire (H) to the positive meter terminal.

Wiring Switch 1:

Normally Open: Use the white and brown wires.

Normally Closed: Use the green and brown wires.

Wiring Switch 2:

Normally Open: Use the blue and orange wires.

Normally Closed: Use the yellow and orange wires.

WIRING DIAGRAM

Line Powered/Loop Powered 4-20mA (Type 2274 XA0)
 4 conductor, 20 AWG shielded

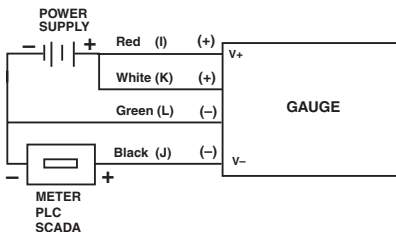
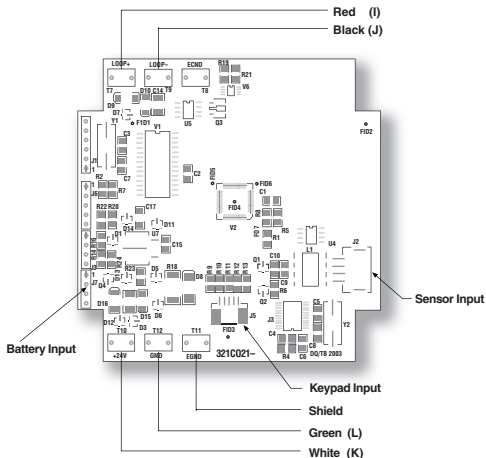

Installation Procedure for 2274 XAO:

 ESD precautions should be taken. See page 31 for details.

1. **Ensure all power is off/disconnected from the circuit.**
2. Connect the white wire (K) to the positive power terminal.
3. Connect the green wire (L) to the negative power terminal.
4. Connect the red wire (I) to the positive power terminal.
5. Connect the black wire (J) to the positive meter terminal.
6. Connect the negative power terminal with the negative meter terminal.

Note: Meter should be installed on the black wire only.

If red/black wires are connected prior to the green/white and power is connected, output may be damaged due to overloading.

Warning: Using multiple power sources for line and loop power is not recommended as it may cause damage to the unit.

WIRING DIAGRAM

Line Powered/Loop Powered 4-20mA with (1) SPDT switch
(Type 2274 XAOU1) 7 conductor, 22 AWG shielded

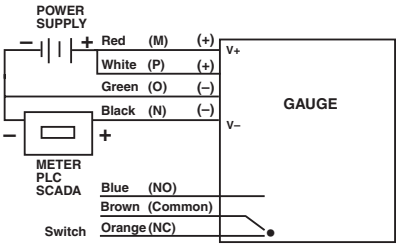
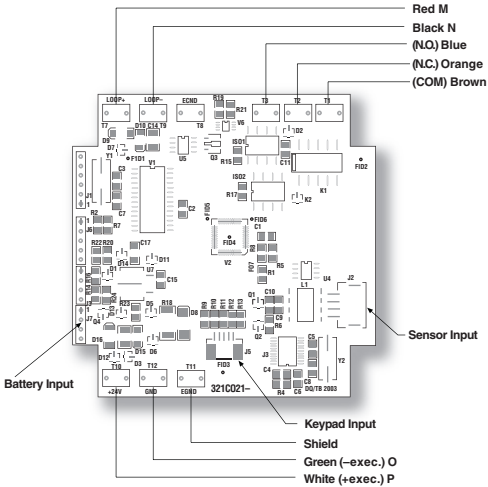

Installation Procedure for 2274 XAOU1:

 ESD precautions should be taken. See page 31 for details.

1. **Ensure all power is off/disconnected from the circuit.**
2. Connect the white wire (P) to the positive power terminal.
3. Connect the green wire (O) to the negative power terminal.
4. Connect the red wire (M) to the positive power terminal.
5. Connect the black wire (N) to the positive meter terminal.
6. Connect the negative power terminal with the negative meter terminal.

Note: Meter should be installed on the black wire only.

If red/black wires are connected prior to the green/white and power is connected, output may be damaged due to overloading.

Wiring the Switch:

Normally Open: Use the blue and brown wires.

Normally Closed: Use the orange and brown wires.

WIRING DIAGRAM

Line Powered/Loop Powered 4-20mA with (2) SPDT switches
(Type 2274 XAOU2) 10 conductor, 22 AWG shielded

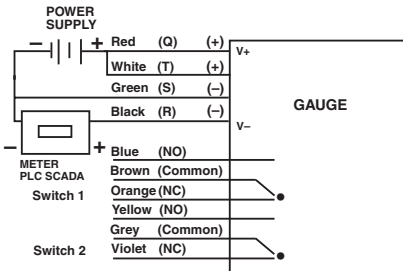
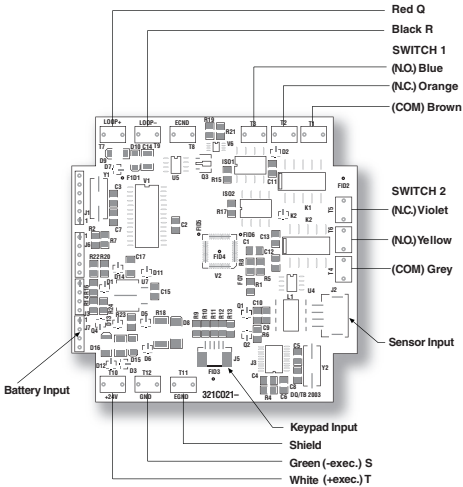

Installation Procedure for 2274 XAOU2:

 ESD precautions should be taken. See page 31 for details.

1. **Ensure all power is off/disconnected from the circuit.**
2. Connect the white wire (T) to the positive power terminal.
3. Connect the green wire (S) to the negative power terminal.
4. Connect the red wire (Q) to the positive power terminal.
5. Connect the black wire (R) to the positive meter terminal.
6. Connect the negative power terminal with the negative meter terminal.

Note: Meter should be installed on the black wire only.

Wiring Switch 1:

Normally Open: Use the blue and brown wires.

Normally Closed: Use the orange and brown wires.

Wiring Switch 2:

Normally Open: Use the yellow and grey wires.

Normally Closed: Use the violet and grey wires.

If red/black wired are connected prior to green/white wires and power is connected, output may be damaged due to overloading.

GAUGE INSTALLATION:

The Ashcroft digital industrial gauge comes standard with either $\frac{1}{4}$ or $\frac{1}{2}$ NPT connection. Good piping practices recommend using teflon tape or a pipe sealant on the gauge threads. Utilize a $\frac{5}{16}$ " (3" case), $\frac{5}{8}$ " (4 $\frac{1}{2}$ " case) wrench on the wrench flat of the gauge to tighten the gauge to the process.

NEVER TIGHTEN GAUGE THREADS BY HOLDING THE BODY OF THE GAUGE. DOING SO MAY DAMAGE THE GAUGE AND MAKE THE GAUGE INOPERABLE.

Battery Installation and Replacement:

The 3" Type 2074 comes with two AA alkaline batteries installed. For battery replacement use;

- Duracell AA alkaline, MN1500 LR06 1.5V

The 4 $\frac{1}{2}$ " Type 2074 comes with two C alkaline batteries installed. For battery replacement use one or the other;

- Energizer C alkaline, E93 or EN93 alkaline LR14 AM2 1.5V
- Duracell C alkaline, MN1400 LR14 1.5V

Do not mix ages or brands of batteries. Do not replace batteries in hazardous areas.

Batteries have a life of approximately 450 hours (3" case). 2500 hours (4 $\frac{1}{2}$ " case). Battery life is dependent on gauge usage, backlite settings and power off settings. When the lower bar of the battery icon of the gauge display flashes, the gauge has approximately 7 hours of life remaining.

To replace the batteries (3" case):

- 1) Remove the single screw on the back of the gauge case.
- 2) Hold the keypad in the palm of hand.
- 3) Carefully remove the two batteries from the holder and replace batteries.

To replace the batteries (4 $\frac{1}{2}$ " case):

- 1) Remove the ring on the front of the gauge case.
- 2) Looking at the gauge case, carefully pull the front face out of the case.
- 3) Lay the gauge, face down on a flat surface.
- 4) Carefully remove the two batteries from the holder and replace the batteries.

ESD PRECAUTIONS

Care should be taken to minimize exposure to ESD. Proper proto-call should be followed as outlined in:

ANSI/ESD S20.20-2007

ESD ADV1.0-2009

ANSI/ESD S541-2008

Additional ESD Precautions on Proper Handling:

Avoid carpets in cool, dry areas as well as other static generating materials such as plastic, cellophane, paper, or cardboard.

Leave digital gauges in their anti-static packaging until ready to be installed.

Dissipate static electricity before handling the digital gauge or using keypad by touching a well-grounded metal object, such as the system unit unpainted metal chassis.

If possible, use antistatic devices, such as wrist straps and floor mats.

When installing batteries, avoid touching (including clothing) the contacts and components.

When making wiring connection to digital gauge terminals, place digital gauge on grounded mat prior to making connection, and take care to avoid touching (including clothing) any components.

Take care when connecting or disconnecting cables. A damaged cable can cause a short in the electrical circuit.

When disconnecting a cable, always pull on the cable connector, case, or strain-relief loop, not on the cable itself.

Notes:

- 1) Do not mix ages or brands of batteries.
- 2) Do not replace batteries in hazardous areas.
- 3) To provide maximum battery life, replace both batteries
- 4) To provide maximum battery life, replace both batteries.

 Pipe to which gauge is attached must be properly grounded.

PANEL MOUNTING DIMENSIONS:

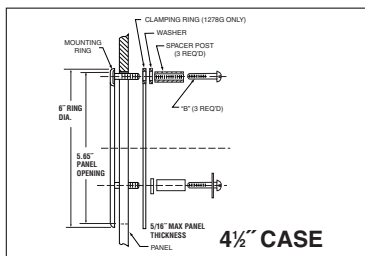
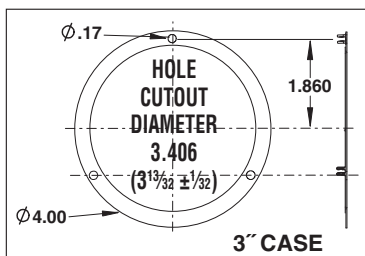

Ashcroft Inc.

250 East Main Street | Stratford, CT 06614-5145

Tel: 203-378-8281 | Fax: 203-385-0602

e-mail: info@ashcroft.com | www.ashcroft.com

I&M008-10109 Rev. F 10/13